



**MAKE YOUR MARK.
MAKE A DIFFERENCE.**



DESIGNED TO PERFORM

Years ago, a building simply had to be structurally sound, cost-effective and serve the needs of the business and occupants inside. Today, architects, builders and building owners must consider so much more, such as:

- Energy efficiency
- Moisture and air infiltration management
- Rising energy costs
- Environmental responsibility

Since the invention of STYROFOAM™ Brand Extruded Polystyrene (XPS) Foam Insulation more than 60 years ago, Dow Building Solutions has helped address all of these issues by employing a design philosophy focused on products that offer:

Durability – High-performance building products from Dow are not only designed to perform a specific function, they are designed to last. This is key to sustainability.

Quality – Dow products have been proven to perform, over and over, in real buildings under real-world conditions.

Innovation – New products and integrated systems, including Dow's three-in-one THERMAX™ Wall System that meets continuous insulation requirements, answer the continually changing needs of the construction industry.

Comfort – Insulation and sealant products from Dow manage air infiltration and moisture to reduce condensation and minimize mold and mildew formation.

Energy Efficiency – Dow insulation, sealant and complementary products enhance the building envelope, reducing fuel consumption.

Sustainability – Dow insulation products provide long-lasting thermal performance, thereby lowering greenhouse gas (GHG) emissions for the life of a building.

Finally, Dow has not lost sight of a constant concern – cost. Its products continue to be a smart investment.

INSTALLED IN OVER 20 MILLION
BUILDINGS WORLDWIDE,
STYROFOAM™ BRAND XPS FOAM
INSULATION INSULATES OVER
20 BILLION FT², SAVING
OVER \$10 BILLION IN ENERGY
COSTS ANNUALLY.

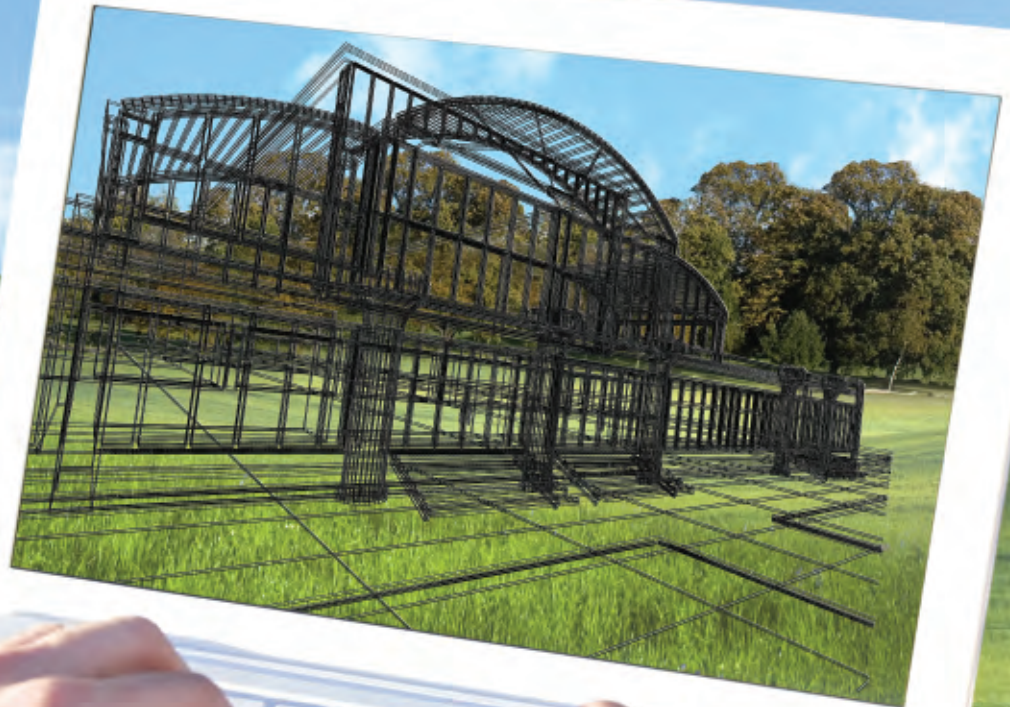

INSULATE TO MAKE A CHANGE FOR THE BETTER

Insulating a building envelope not only enhances the building's energy efficiency, it's a cost-effective way to reduce GHG emissions.

According to this graph, an investment in insulation has the most potential for generating positive economic returns over a building's life cycle, while helping reduce GHG emissions. Starting first with the lowest marginal cost GHG abatement options – insulation improvements – can have an immediate positive impact on the environment, on the sustainability of buildings around the world and on the bottom line for businesses globally.

Research results are consistent with what Dow and the building industry have known for many years: **Building insulation is one of the best ways to reduce GHG emissions, save money and boost economic growth.**

ENVISION THE BENEFITS

Green building practices are gaining popularity as more people learn that opting for energy efficiency no longer always means paying a premium price.

- Rebates and tax credits are on the rise for builders who construct green buildings
- Products that contribute to sustainability are more widely available and cost-competitive
- Green buildings are in demand by building owners who want to lower operating costs and maintain higher resale value

From the architect's plan to the builder's energy-efficiency mindset, Dow is ready to help turn the entire vision into a highly functional building with the owner's bottom line and the global environment as top priorities.

MEET LEED AND BEYOND

The U.S. Green Building Council's Leadership in Energy and Environmental Design (LEED) system is a voluntary, consensus-based standard that recognizes the life-cycle costing of construction. Through the LEED program, design professionals accumulate credits based on meeting criteria for the use of environmentally friendly, sustainable and energy-efficient products and systems.

For more information about LEED, visit www.usgbc.org.

Leading Products

Energy-efficient Dow products may contribute to significant LEED credits in a wide range of commercial foundation/slab,

BUILDING INSULATION COST-EFFECTIVELY REDUCES GREENHOUSE GAS EMISSIONS GLOBALLY

The cost of cutting GHG emissions in different ways

Marginal cost of abatement, examples €/t CO₂

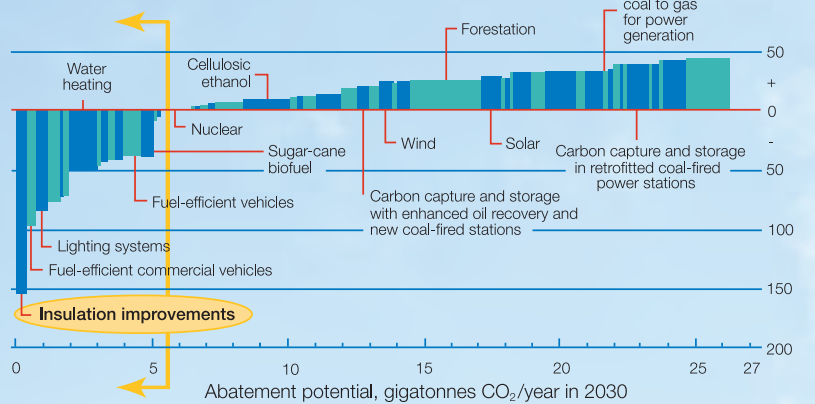

Source: Study conducted by McKinsey & Company, and Vattenfall

McKinsey & Company studied the costs of implementing various GHG abatement options. "Insulation improvements" is among the more economical measures at the left of the graph that provide the fastest payback and should be implemented before doing any of the other measures. And as the graph shows, "insulation improvements" is by far the best measure in terms of a negative marginal cost. This graph represents only a few of the abatement options researched. For the graph in its entirety, visit www.mckinseyquarterly.com/A_cost_curve_for_greenhouse_gas_reduction_1911.

THE ARCHITECTURE 2030 ORGANIZATION HAS
ISSUED A CHALLENGE: REDUCE FOSSIL-FUEL
CONSUMPTION BY 50 PERCENT IN ALL NEW
BUILDINGS AND MAJOR RENOVATIONS BY 2010,
INCREASING THE REDUCTION UNTIL NEW
BUILDINGS ARE CARBON NEUTRAL BY 2030.

– WWW.ARCHITECTURE2030.ORG

roof and wall applications. Our brand-leading offering includes:

- STYROFOAM™ Brand Extruded Polystyrene Foam Insulation
- THERMAX™ Polyisocyanurate Insulation
- THERMAX™ Wall System
- STYROFOAM™ Brand Spray Polyurethane Foam (CM Series)
- FROTH-PAK™ Foam Insulation and FROTH-PAK™ Foam Sealant
- GREAT STUFF PRO™ Insulating Foam Sealants
- WEATHERMATE™ Straight Flashing
- INSTA STIK™ Quik Set Commercial Roofing Adhesive
- TILE BOND™ Roof Tile Adhesive

©™Trademark of The Dow Chemical Company ("Dow") or an affiliated company of Dow

FOUNDATIONS AND SLABS

ABOVE GRADE AND BELOW GRADE

Rigid foam insulation products from Dow offer excellent insulation and moisture protection in foundation and slab applications. Extruded polystyrene foam insulation from Dow offers a combination of benefits for almost any application.

- Long-term thermal performance
- High compressive strength
- Ease of use
- Excellent moisture resistance
- Waterproofing protection

FOUNDATIONS

PRODUCTS:

- STYROFOAM™ Brand PERIMATE™ Insulation
- STYROFOAM™ Brand Square Edge Insulation
- STYROFOAM™ Brand SCOREBOARD™ Insulation
- DOW™ Protection Board III Insulation

APPLICATION:

Install extruded polystyrene foam insulation from Dow against the exterior foundation wall. When properly installed, the insulation resists moisture, so it offers more stable long-term R-value* in moist foundation applications.

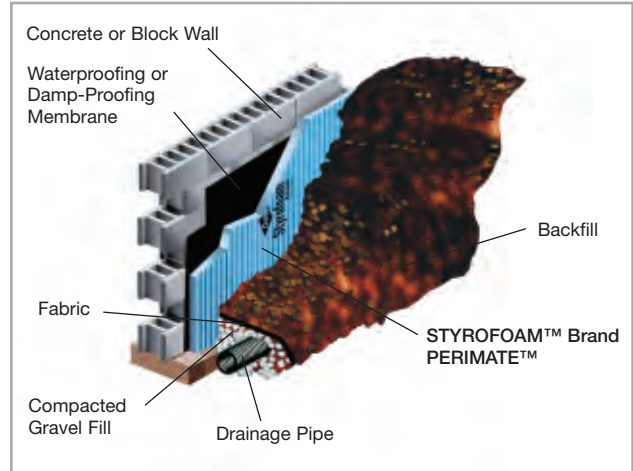

STYROFOAM™ Brand PERIMATE™ Insulation features drainage grooves to direct water away from the foundation, offering thermal insulation and drainage of subsurface soil in a single step.

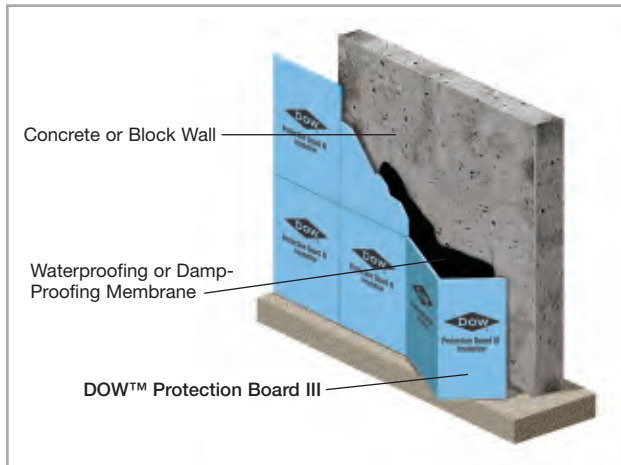

Fanfolded on 24" centers with plastic film on one side, DOW™ Protection Board III Insulation is durable yet easy to install and work with on the job site.

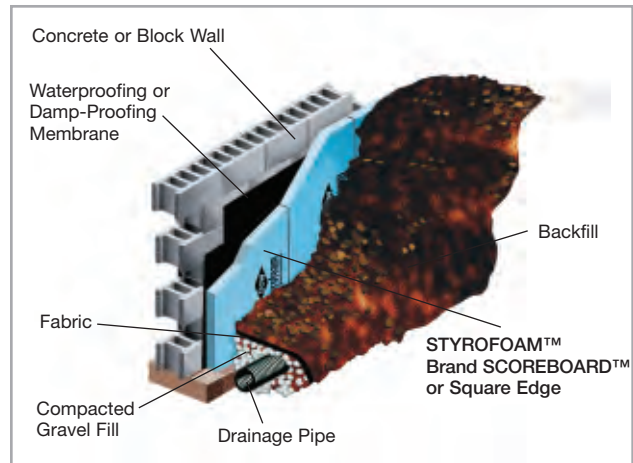

STYROFOAM™ Brand Square Edge Insulation and STYROFOAM™ Brand SCOREBOARD™ Insulation provide long-term thermal performance.

For more detailed installation information, contact your Dow representative or refer to the product literature.

®™Trademark of The Dow Chemical Company ("Dow") or an affiliated company of Dow
*R means resistance to heat flow. The higher the R-value, the greater the insulating power.

RADIANT FLOOR – UNDER SLAB

PRODUCTS:

- STYROFOAM™ Brand Tongue and Groove Insulation
- STYROFOAM™ Brand Square Edge Insulation
- STYROFOAM™ Brand HIGHLOAD 40, 60 or 100 Insulation

APPLICATION:

Install STYROFOAM™ Brand Extruded Polystyrene Foam Insulation under the slab to help provide moisture protection and to prevent radiant floor heat from dissipating into the ground.

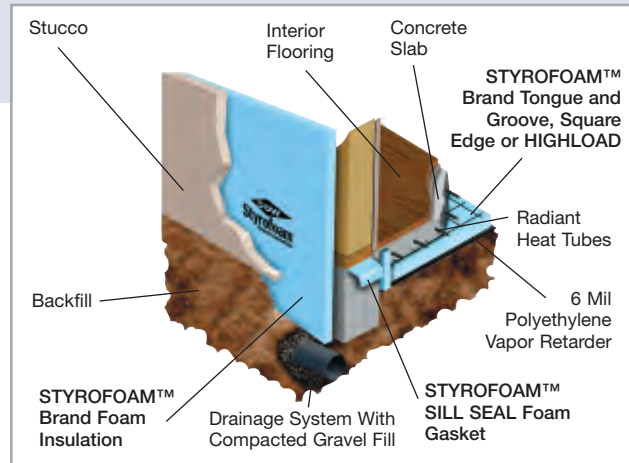

STYROFOAM™ Brand Extruded Polystyrene Foam Insulation offers excellent moisture resistance and insulating power in slab-on-grade radiant floor applications.

RADIANT FLOOR – OVER DECK/ SUBFLOOR

PRODUCTS:

- STYROFOAM™ Brand SCOREBOARD™ Insulation
- STYROFOAM™ Brand Square Edge Insulation
- STYROFOAM™ Brand WALLMATE™ Insulation

APPLICATION:

Use in upper level floors in new construction or over the slab in a retrofit situation. Extruded polystyrene foam insulation from Dow helps direct radiant floor heat upward, into the room.

Consult local building code official for construction specifics.

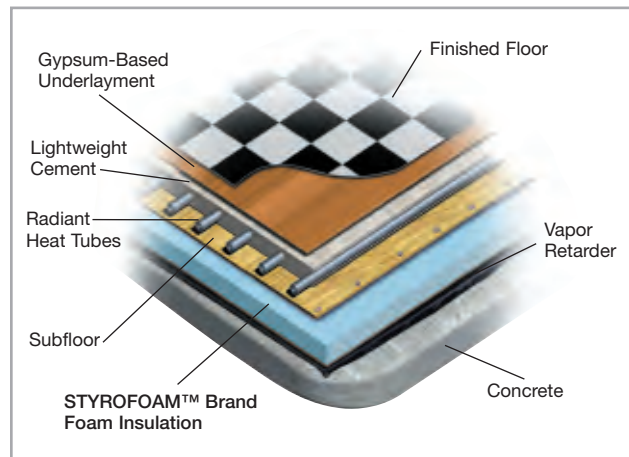

Assembly for new construction for an upper level floor or as a retrofit over existing slab. If no vapor retarder was installed under the existing slab, it is recommended to add one between the slab and the rigid foam insulation. A vapor retarder is not needed if the deck is a second-floor application.

GEOTECHNICAL

PRODUCTS:

- STYROFOAM™ Brand HIGHLOAD 40, 60 or 100 Insulation
- STYROFOAM™ Brand Square Edge Insulation

APPLICATION:

Use wherever excellent load-bearing, insulating and moisture-resistance capabilities are needed, including under building floor slabs; airport runways, taxiways and aprons; railroads; culverts; retaining walls; storage tank slabs; and swimming pools.

Lay STYROFOAM™ Brand Extruded Polystyrene Foam Insulation on top of leveled soil. Top with a gravel base and pavement or other surface. For low-temperature floors such as ice rinks, position insulation under the wearing slab.

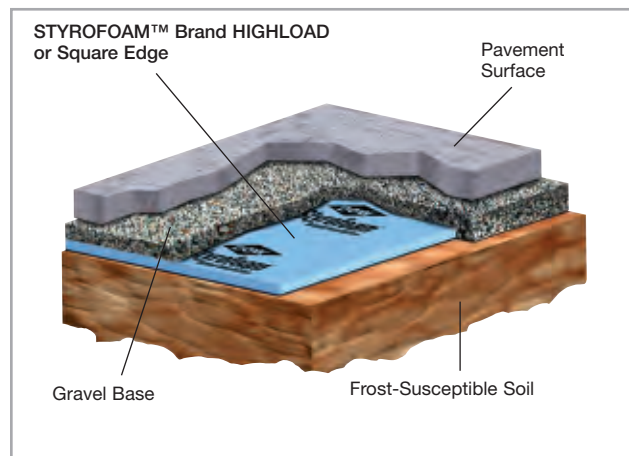

STYROFOAM™ Brand HIGHLOAD Insulation has been developed specifically for in-ground applications.

[ROOFS]

PLAZA AND PROTECTED MEMBRANE

STYROFOAM™ Brand Extruded Polystyrene Foam Insulation offers exceptional performance in plaza and protected membrane roofing (PMR) applications.

- Excellent moisture resistance and stable long-term R-value
- Extends life of plaza or roof, providing protection from ultraviolet deterioration

- Protects membrane against weathering, physical abuse and damage
- Maintains membrane at a relatively constant temperature, minimizing effects of freeze-thaw cycling and excessive heat
- Reduces repair expenditures
- Easy removal and re-installation of ballast and insulation

- PRODUCTS:**
- STYROFOAM™ Brand HIGHLOAD 40, 60 or 100 Insulation
 - STYROFOAM™ Brand PLAZAMATE™ Insulation
 - STYROFOAM™ Brand ROOFMATE™ Insulation
 - STYROFOAM™ Brand Ribbed ROOFMATE™ Insulation

APPLICATION:

Install on top of the waterproofing membrane. Follow with approved fabric. For PMR construction, finish with a layer of crushed stone, gravel, pavers or green roof. For plaza decks where pedestrian or vehicular traffic is anticipated, cover fabric with gravel or pedestals for drainage, then top with pavers, poured concrete or other exterior topping.

- Year-round construction – roof is waterproofed first, then insulated
- Over forty years' proven performance
- Thermal warranties available from Dow; full system warranties available from membrane manufacturers

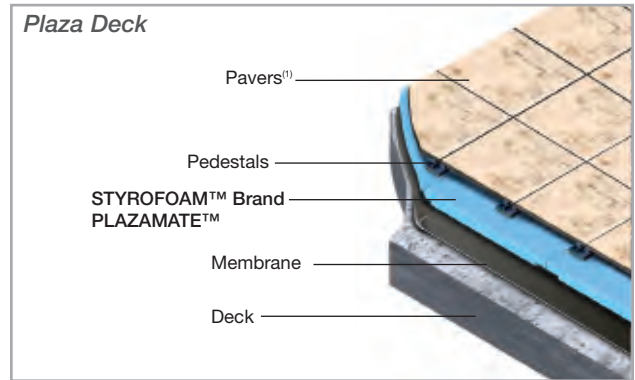
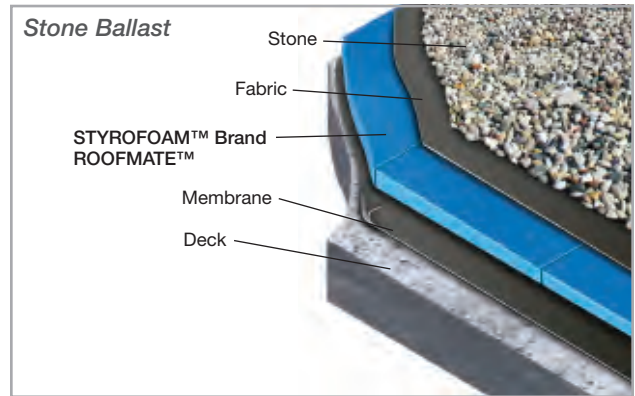

STYROFOAM™ Brand PLAZAMATE™ Insulation is designed to hold up under the heavy demands of plaza roof construction.

(1) Pavers require pedestals unless STYROFOAM™ Brand Ribbed ROOFMATE™ Insulation is used.

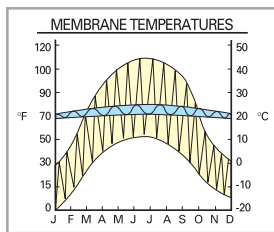

MEMBRANE FIELD TEMPERATURE TEST

Membrane protection (PMR vs. conventional): Field studies have shown that a constant temperature can extend the life of the membrane. STYROFOAM™ Brand ROOFMATE™ Insulation

products offer excellent temperature control.

- PMR (blue line) – the membrane temperature remains relatively constant
- Conventional roof (yellow line) – membrane temperature fluctuates widely

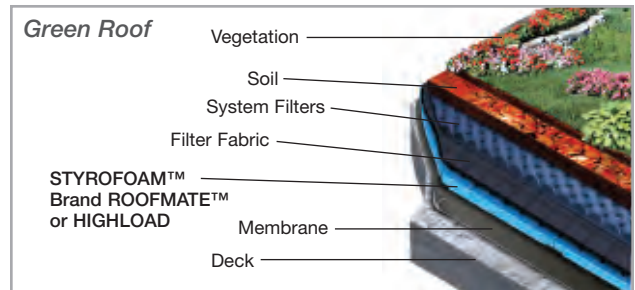

For more detailed installation information, contact your Dow representative or refer to the product literature.

©™Trademark of The Dow Chemical Company ("Dow") or an affiliated company of Dow

CONVENTIONAL – MECHANICALLY ATTACHED, BALLASTED AND FULLY ADHERED

In conventional roofing applications, STYROFOAM™ Brand Extruded Polystyrene Foam Insulation products from Dow offer:

- Long-term R-value
- Moisture resistance
- High compressive strength for excellent durability and damage resistance
- Ease of use

- Planed surface for excellent bonding of adhesives (STYROFOAM™ Brand DECKMATE™ Plus FA Insulation)

STYROFOAM™ Brand Extruded Polystyrene Foam Insulation may be installed directly on metal decks according to Underwriters Laboratories Construction Nos. 260 and 440. Consult Dow and/or local building code for installation requirements.

PRODUCTS:

- STYROFOAM™ Brand DECKMATE™ Plus Insulation
- STYROFOAM™ Brand DECKMATE™ Plus FA Insulation
- STYROFOAM™ Brand Tapered DECKMATE™ Plus FA Insulation

APPLICATION:

Install insulation directly on structural deck, including metal decking. Any application-appropriate roofing membrane may be used with rigid board insulation from Dow.

In some cases a coverboard or slip sheet may be required between the insulation and the membrane for heat or chemical protection.

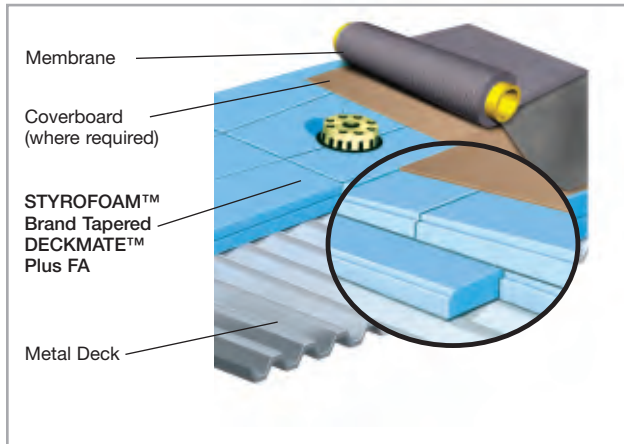

STYROFOAM™ Brand Tapered DECKMATE™ Plus FA Insulation provides a positive slope to improve roof drainage. Experienced custom fabricators provide exceptional job service. Consult Dow and/or local building code for installation requirements.

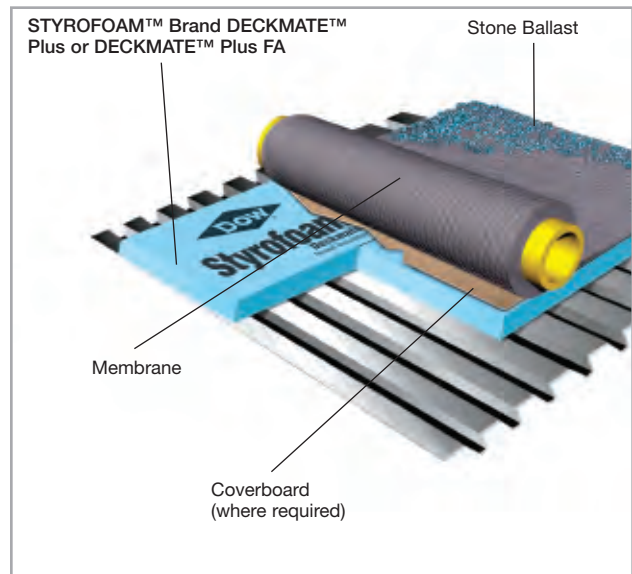

STYROFOAM™ Brand DECKMATE™ Plus Insulation and STYROFOAM™ Brand DECKMATE™ Plus FA Insulation have a 15-year limited thermal performance warranty when properly installed. A 30-year reuse warranty for STYROFOAM™ Brand DECKMATE™ Plus Insulation is also available. Certain conditions apply; see the appropriate warranty for details.

STEEP SLOPE

In steep slope roof construction, insulation and adhesive products from Dow offer high R-value, high compressive strength, durability and ease of use.

- For use on metal or wood decks
- Accept a variety of roofing materials, including shingles, slate, tile and metal membranes
- STYROFOAM™ Brand DECKMATE™ Plus Extruded Polystyrene Foam Insulation offers excellent moisture resistance

- In standing seam metal roofs, THERMAX™ Polyisocyanurate Insulation allows the use of lighter gauge decking (26 gauge instead of the typical 22 gauge) and open frame designs
- WEATHERMATE™ Straight Flashing at seams between insulation boards resists water intrusion under standing seam metal roofs

PRODUCTS:

- STYROFOAM™ Brand DECKMATE™ Plus Insulation
- THERMAX™ Heavy Duty
- THERMAX™ Light Duty
- THERMAX™ Metal Building Board
- THERMAX™ Sheathing
- THERMAX™ White Finish
- WEATHERMATE™ Straight Flashing

APPLICATION:

Install insulation on clean, dry, structural roof deck. Cover with an underlayment where required. Finish with shingles, tile, slate, metal or other roofing material.

Available in 4", 6" and 9" widths, WEATHERMATE™ Straight Flashing combines a high-density polyethylene film facer with a butyl rubber adhesive for a strong mechanical and chemical bond to insulation and other building materials.

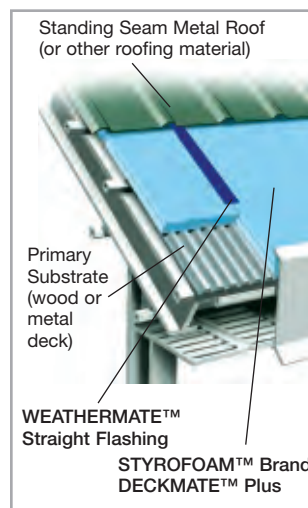

STYROFOAM™ Brand DECKMATE™ Plus Insulation provides excellent moisture resistance and high R-value in a lightweight board.

Use Class A rated THERMAX™ products in open frame designs, where the insulation boards may be left exposed to the interior. Tape top side of seams with WEATHERMATE™ Straight Flashing.

†For air sealing the roof/wall juncture

ROOF RE-COVER APPLICATIONS

STYROFOAM™ Brand RECOVERMATE CR Insulation is designed specially for roof re-cover applications:

- Resistant to the effects of moisture
- Excellent compressive retention
- Lightweight: easy to cut, handle, install and store

- Withstands temperatures to 165°F
- Chemical-resistant; useful for installation with plasticized membranes
- Fanfolded
- For light-colored membranes only

PRODUCT:

- STYROFOAM™ Brand RECOVERMATE CR Insulation

APPLICATION:

Install STYROFOAM™ Brand RECOVERMATE CR Insulation over entire surface of old roof, on top of existing membrane. Top with ballasted or mechanically attached sheet membrane.

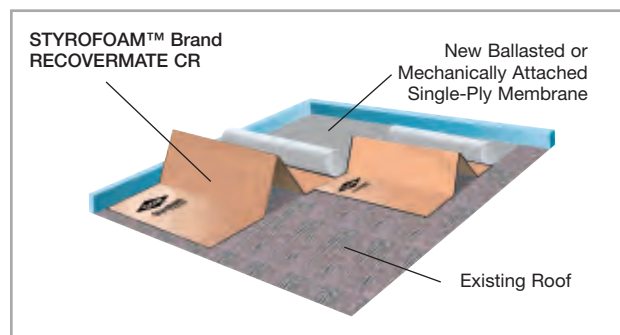

For more detailed installation information, contact your Dow representative or refer to the product literature.

©™Trademark of The Dow Chemical Company ("Dow") or an affiliated company of Dow

ONE- AND TWO-COMPONENT POLYURETHANE FOAM PRODUCTS FOR ROOFS

Polyurethane foam insulation, sealant and adhesive products from Dow deliver the high quality and reliability professionals require in a wide range of commercial roofing applications, including:

- Flat and low slope roofs
- Steep slope roofs
- Barrel and dome roofs
- Roof re-cover projects
- New and re-roof projects

SEALANT

PRODUCT:

- FROTH-PAK™ Foam Sealant**

APPLICATION:

Use FROTH-PAK™ Foam Sealant to fill gaps or joints 8" or less. When properly applied, the spray forms an effective air sealant or insulation on most roofing materials. FROTH-PAK™ Foam Sealant is also useful in sealing the perimeter of the building between the roof deck and parapet.

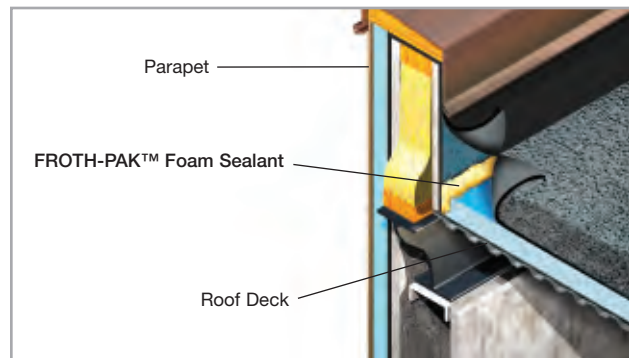

ADHESIVES

PRODUCTS:

- INSTA STIK™ Quik Set Commercial Roofing Adhesive**
- TILE BOND™ Roof Tile Adhesive**

APPLICATION:

Polyurethane adhesive products from Dow provide a fast, efficient method for securing foam insulation boards or roof tiles to appropriate roof deck or substrate.

INSTA STIK™ Quik Set has a limited 10-year adhesion warranty when applied to compatible materials or substrates by an approved applicator. Limited 15- and 20-year adhesion warranties are available at additional cost. Certain conditions apply; see the appropriate warranty for details.

TILE BOND™, with its easy-to-use, self-contained dispensing equipment, is designed for use with low/flat, medium, high and two-piece barrel profiles. TILE BOND™ must be applied by an approved applicator to meet certain building code requirements. Consult local code authorities.

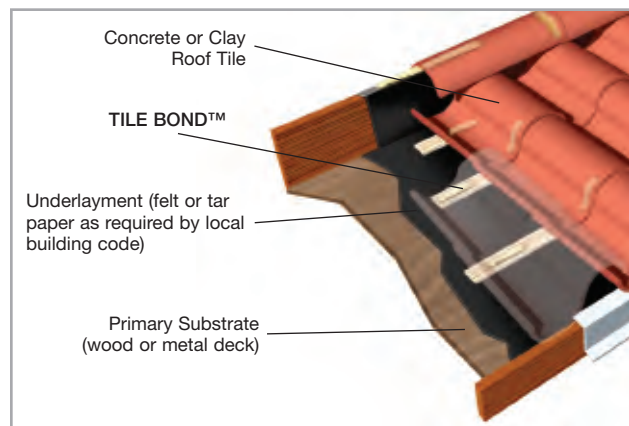
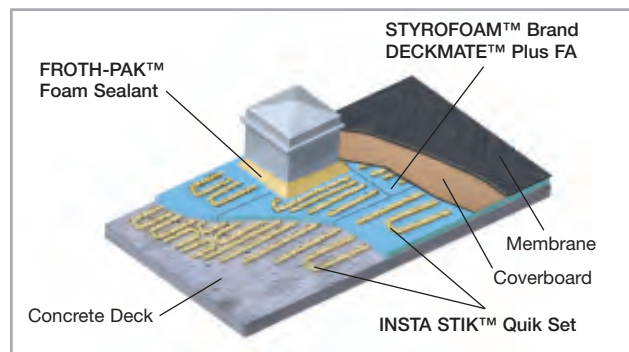

TILE BOND™ Roof Tile Adhesive adheres concrete or clay tiles to the roof deck/substrate. Refer to tile manufacturer's instructions for details.

For more detailed installation information, contact your Dow representative or refer to the product literature.

®™Trademark of The Dow Chemical Company ("Dow") or an affiliated company of Dow
**Consult the instructions and Material Safety Data Sheets carefully before use.

WALLS

INTERIOR AND EXTERIOR

With rigid foam insulation from Dow on the walls, your building can perform more efficiently. These products offer:

- Excellent long-term thermal performance
- Ease of use

- Moisture resistance
- Reusability in some situations

Note: Applicable codes may require a 15-minute thermal barrier between insulation and occupied space.

EXTERIOR CAVITY WALL – STEEL STUD

PRODUCTS:

- STYROFOAM™ Brand CAVITYMATE™ SC Insulation
- THERMAX™ Sheathing
- THERMAX™ (ci) Exterior Insulation
- THERMAX™ Metal Building Board
- WEATHERMATE™ Straight Flashing

APPLICATION:

Install rigid foam insulation on the exterior of steel stud cavity walls and face with brick or other exterior cladding. Rigid foam insulation helps minimize thermal shorts through the steel studs.

For a tear-resistant seal that resists water intrusion, Dow recommends taping seams between insulation boards with WEATHERMATE™ Straight Flashing.

Meets ASHRAE 90.1-2007 prescriptive requirements for continuous insulation

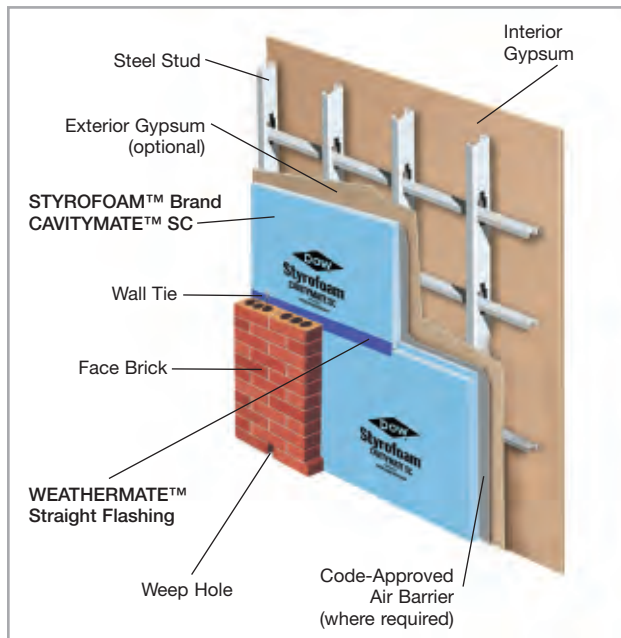

EXTERIOR CAVITY WALL – THERMAX™ WALL SYSTEM

PRODUCTS:

- THERMAX™ (ci) Exterior Insulation
- STYROFOAM™ Brand Spray Polyurethane Foam¹ (SPF) (CM Series)
- WEATHERMATE™ Straight Flashing

APPLICATION:

Install THERMAX™ (ci) Exterior Insulation over steel studs with sheathing joints and other thru-wall penetrations protected by WEATHERMATE™ Straight Flashing. After closing in the building, create an effective air barrier by spraying STYROFOAM™ Brand SPF (CM Series) on the interior of the THERMAX™ (ci) Exterior Insulation in the stud cavity.

- Three-in-one construction for maximum design efficiency
- Integral, durable acrylic-coated aluminum facer provides drainage plane and water-resistive barrier
- Lightweight sheathing weighs just 12 lbs per board, speeding up the construction process

Meets ASHRAE 90.1-2007 prescriptive requirements for continuous insulation

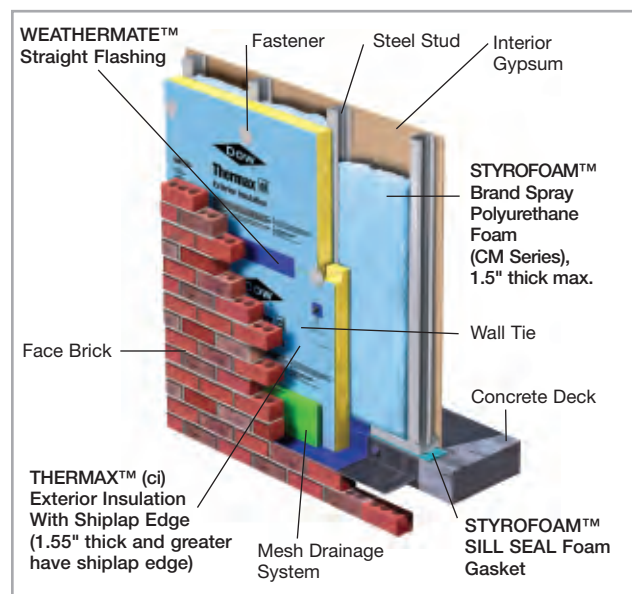

For more detailed installation information, contact your Dow representative or refer to the product literature.

¹Trademark of The Dow Chemical Company ("Dow") or an affiliated company of Dow
¹STYROFOAM™ Brand Spray Polyurethane Foam should be installed by a trained SPF applicator wearing protective clothing, gloves, goggles and proper respiratory protection. Consult the instructions and Material Safety Data Sheets carefully before use.

EXTERIOR CAVITY WALL – BLOCK BACKED

PRODUCTS:

- STYROFOAM™ Brand CAVITYMATE™ Insulation
- STYROFOAM™ Brand CAVITYMATE™ Plus Insulation
- STYROFOAM™ Brand CAVITYMATE™ Ultra Insulation

APPLICATION:

Install insulation on the exterior of block-backed cavity walls.

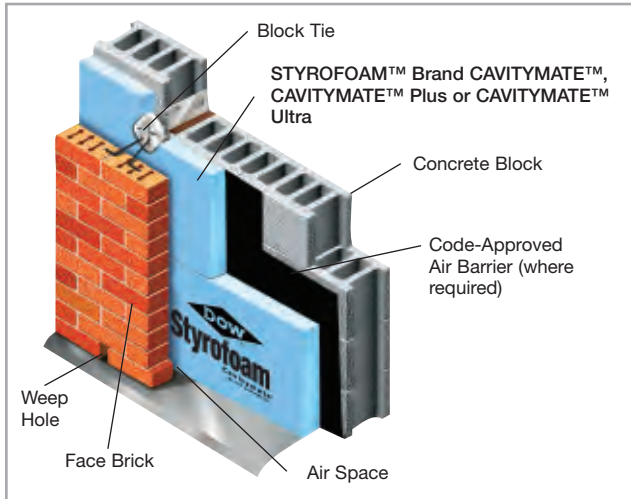

STYROFOAM™ Brand CAVITYMATE™ Insulation is designed specifically for moist cavity wall environments.

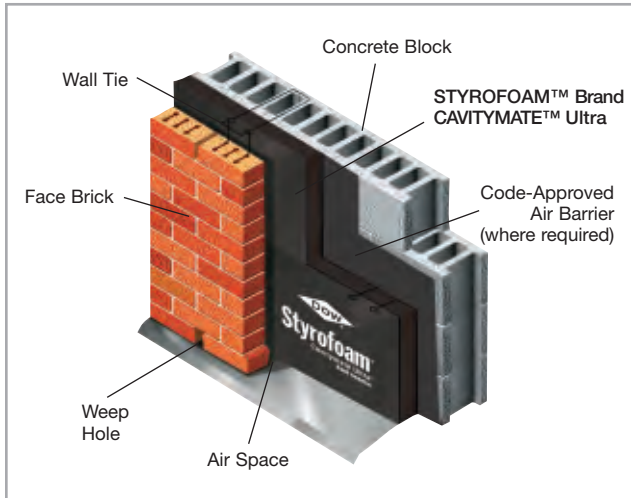

Manufactured with a distinct carbon black technology to absorb infrared radiation, STYROFOAM™ Brand CAVITYMATE™ Ultra Insulation has an R-value of 5.6 per inch. This is the highest R-value of all STYROFOAM™ Brand XPS Foam Insulation products.

For more detailed installation information, contact your Dow representative or refer to the product literature.

METAL BUILDING

PRODUCTS:

- THERMAX™ Metal Building Board
- THERMAX™ Heavy Duty Plus (for wall applications only)
- THERMAX™ Heavy Duty
- THERMAX™ Light Duty
- THERMAX™ Sheathing

APPLICATION:

Install insulation between wall girts and metal siding.

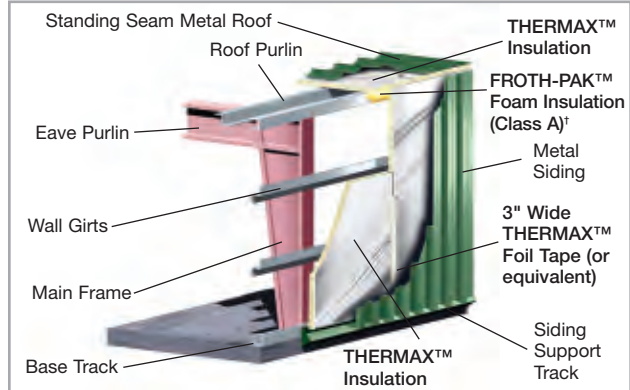

THERMAX™ Insulation products help safeguard pre-engineered metal buildings against thermal loss and moisture buildup. A variety of thicknesses and lengths up to 30' are available to meet specific design requirements.

†For air sealing the roof/wall juncture

EXTERIOR PRECAST

PRODUCTS:

- STYROFOAM™ Brand Square Edge Insulation
- ISOCAST™ R Insulation

APPLICATION:

Used in insulated precast, prestressed or tilt-up construction, rigid foam insulation products from Dow combine insulating capabilities with the added strength of concrete. The foam is sandwiched between two wythes of concrete and held together structurally by metal or nonconductive connectors.

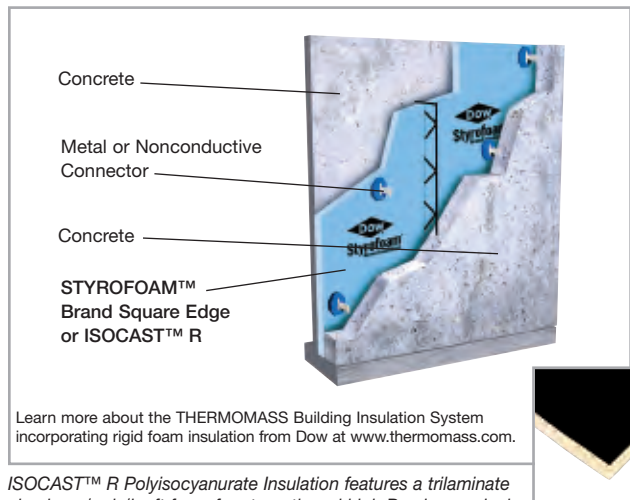

Learn more about the THERMOMASS Building Insulation System incorporating rigid foam insulation from Dow at www.thermomass.com.

ISOCAST™ R Polyisocyanurate Insulation features a trilateral aluminum/poly/kraft facer for strength and high R-value per inch in precast concrete walls.

©™Trademark of The Dow Chemical Company ("Dow") or an affiliated company of Dow

INTERIOR – EXPOSED WALL

PRODUCTS:

- THERMAX™ Heavy Duty Plus
- THERMAX™ Heavy Duty
- THERMAX™ Light Duty

APPLICATION:

For best results, install against interior of structural wall with the Interlocking System joint closure. Ask your seller about other installation methods. Distinct, easy-to-clean facers of aluminum and/or acrylic-coated aluminum make THERMAX™ Polyisocyanurate Insulation ideal for exposed interior walls, adding durability and moisture control. With THERMAX™ Insulation, there is no need for drywall or gypsum board.

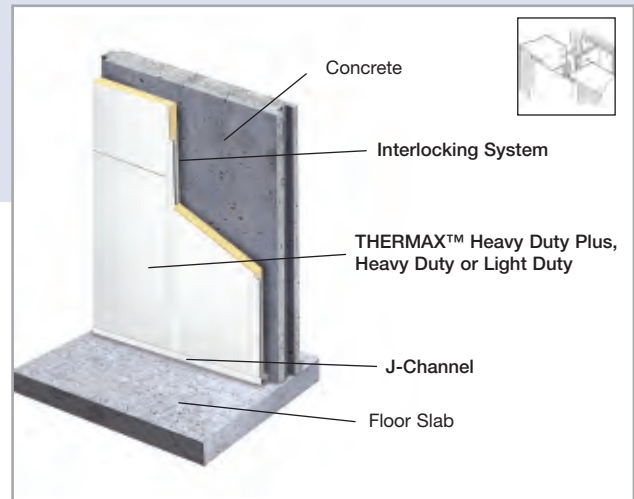

INTERIOR – CONCEALED WALL

PRODUCTS:

- STYROFOAM™ Brand Z-MATE™ Insulation
- STYROFOAM™ Brand Square Edge Insulation
- THERMAX™ Sheathing
- TUFF-R™ Commercial Insulation
- Super TUFF-R™ Commercial Insulation
- GREAT STUFF PRO™ Gaps & Cracks Insulating Foam Sealant††

APPLICATION:

Install rigid foam insulation between furring strips. Cover with an approved thermal barrier.

A bead of GREAT STUFF PRO™ Gaps & Cracks Insulating Foam Sealant helps to seal the wall/slab joint.

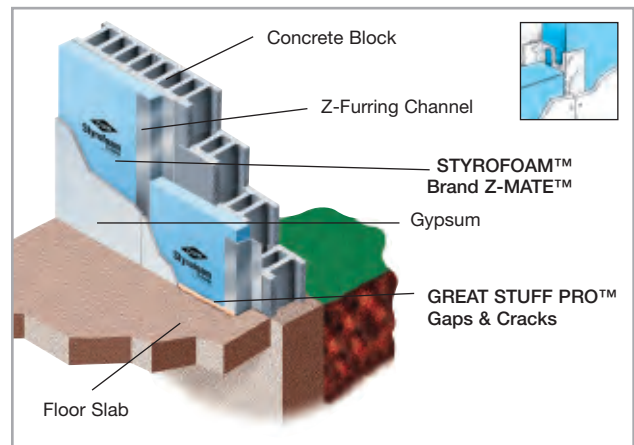

STYROFOAM™ Brand Z-MATE™ Insulation, nominally 24" wide, is pre-cut to 23-7/8", so it can be installed between Z-furring channels placed on 24" centers.

ONE- AND TWO-COMPONENT POLYURETHANE FOAM SEALANTS†† FOR WALLS

PRODUCTS:

- FROTH-PAK™ Foam Insulation
- GREAT STUFF PRO™ Gaps & Cracks Insulating Foam Sealant
- GREAT STUFF PRO™ Window & Door Insulating Foam Sealant



FROTH-PAK™ Foam Insulation is ideal for sealing areas 6" wide or less (max. 2" thick) and can be left exposed per NFPA 286 in roof/wall junctures.

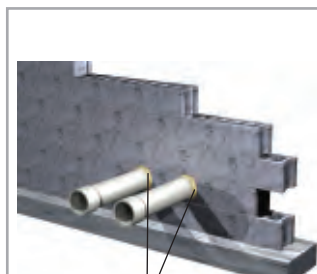

Seal smaller areas, such as gaps around pipe penetrations, with GREAT STUFF PRO™ Gaps & Cracks Insulating Foam Sealant.

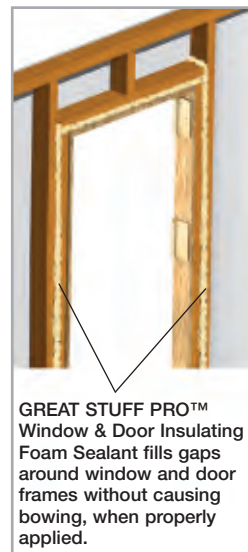

GREAT STUFF PRO™ Window & Door Insulating Foam Sealant fills gaps around window and door frames without causing bowing, when properly applied.

For more detailed installation information, contact your Dow representative or refer to the product literature.

®™Trademark of The Dow Chemical Company ("Dow") or an affiliated company of Dow
††Consult the instructions and Material Safety Data Sheet carefully before use.

STYROFOAM™ BRAND EXTRUDED POLYSTYRENE FOAM INSULATION

Physical Properties	Property (units)	Thermal Resistance ^(1,2) aged @ 75°F, mean temp	Compressive Strength (lb/in ²), min. ⁽³⁾	Flexural Strength (lb/in ²), min.	Water Absorption (% by volume), max.	Water Vapor Permeance ⁽⁴⁾ (perm), max.	Dimensional Stability (% linear change), max.	Coefficient of Linear Thermal Expansion (x10 ⁻⁶ in/in/°F)	Complies with ASTM C578, Type ⁽⁵⁾	Maximum Use Temperature (°F)	Flame Spread ⁽⁶⁾	Smoke Developed	Width (inches)	Length (inches)	Typical Thickness Range (inches)
ASTM Method	C518	D1621	C203	C272	E96	D2126				E84	E84				
CAVITYMATE™	5.0	15	40	0.3	1.5	2.0	3.5	X	165	15	165	16	96	1.0, 1.5, 2.0, 3.0	
CAVITYMATE™ SC	5.0	15	40	0.3	1.5	2.0	3.5	X	165	15	165	48	96	1.0, 1.5, 2.0, 2.5	
CAVITYMATE™ Plus	5.0	25	50	0.3	1.5	2.0	3.5	IV	165	15	165	16	96	1.0, 1.5, 2.0	
CAVITYMATE™ Ultra	1.75" R-100 2.13" R-120	25	50	0.3	1.5	2.0	3.5	IV	165	10	160	16	96	1.75, 2.13	
DECKMATE™ Plus	5.0	25	50	0.3	1.5	2.0	3.5	IV	165	15	165	24 48	96 96	1.0, 1.5, 2.0, 2.5, 3.0, 4.0	
DECKMATE™ Plus FA (Flat and Tapered)	5.0	25	50	0.3	1.5	2.0	3.5	IV	165	15	165	24	96	1.5, 2.0, 2.5, 3.0, 4.0 1/8", 1/4", 1/2" slopes	
FREEZERMATE™	5.0	30	50	0.3	1.5	2.0	3.5	IV	165	15	165	24 48	96 96	2.0, 3.0	
PERIMATE™	1.063" R-5.0 2.125" R-100	30	50	0.3	1.5	2.0	3.5	IV	165	15	165	24	96	1.063, 2.125	
PLAZAMATE™	5.0	60	75	0.3	0.8	2.0	3.5	VII	165	15	165	24	96	2.0, 3.0	
RECOVERMATE CR	1.5 ⁽⁷⁾	15	-	0.3	1.8	2.0	3.5	-	165	10	200-350	48	600	0.375	
ROOFMATE™	5.0	40	60	0.3	1.0	2.0	3.5	VI	165	15	165	24	96	1.0, 1.5, 2.0, 2.5, 3.0, 3.5, 4.0	
Ribbed ROOFMATE™	5.0	40 ⁽⁸⁾	60	0.3	1.0	2.0	3.5	VI	165	15	165	24	96	2.0	
WALLMATE™	5.0	15	40	0.3	1.5	2.0	3.5	X	165	15	165	24	96	1.5, 2.0	
Z-MATE™	5.0	15	40	0.3	1.5	2.0	3.5	X	165	15	165	24	96	1.5, 2.0	
Protection Board III	1.0 ⁽⁹⁾	10	-	2.0	1.5 ⁽⁹⁾	-	-	-	165	10	165	48	600	0.25	
HIGHLOAD 40	5.0	40	60	0.3	1.0	2.0	3.5	VI	165	15	165	24 48	96 96	2.0, 3.0	
HIGHLOAD 60	5.0	60	75	0.3	0.8	2.0	3.5	VII	165	15	165	24	96	2.0, 3.0	
HIGHLOAD 100	5.0	100	100	0.1	0.8	2.0	3.5	V	165	15	165	24	96	2.0	
SCOREBOARD™ ⁽¹⁰⁾	5.0	25	50	0.3	1.5	2.0	3.5	IV	165	15	165	48	96	0.75, 1.0, 1.5, 2.0, 2.5, 3.0	
Square Edge ⁽¹⁰⁾	5.0	25	50	0.3	1.5	2.0	3.5	IV	165	15	165	24 48	96 96	0.75, 1.0, 1.5, 2.0, 2.5, 3.0, 4.0	
Tongue and Groove	5.0	25	50	0.3	1.5	2.0	3.5	IV	165	15	165	24 48	96 96	0.75, 1.0, 1.5, 2.0	

(1) Values are consistent with the criteria of ASTM C578 and the requirements of the FTC R-value rule (16 CFR Part 460). A 15-year limited thermal warranty is available.

(2) R means resistance to heat flow. The higher the R-value, the greater the insulating power. R-values are expressed in ft²•h•°F/Btu.

(3) Vertical compressive strength is measured at 10% deformation (5% for STYROFOAM™ Brand PLAZAMATE™ Insulation and for STYROFOAM™ Brand HIGHLOAD 40, 60 and 100 Insulation) or at yield, whichever occurs first. Since STYROFOAM™ Brand Extruded Polystyrene Foam Insulation is a visco-elastic material, adequate design safety factors should be used to prevent long-term creep and fatigue deformation. For static loads, 3:1 is suggested. For dynamic loads, 5:1 is suggested.

(4) Water vapor permeance varies with product type and thickness. Values are based on the desiccant method, and they apply to insulation 1" in thickness. Thicker products have lower permeance.

(5) Former Federal Specification HH-I-524C was cancelled in 1985 and replaced by ASTM Specification C578.

(6) This numerical flame spread rating is not intended to reflect hazards presented by this or any other material under actual fire conditions.

(7) For 3/8" thickness.

(8) Recommended load (psf) including 5:1 design factor.

(9) For 1/4" thickness; perm-inches.

(10) If using product for Z-furring applications, contact your local Dow sales representative for exact product sizes.

Note: Not all products are available in all parts of the country. Other product sizes are available on a made-to-order basis. Contact your Dow representative with questions.

DOW POLYISOCYANURATE INSULATION

Physical Properties	Property (units)	Thermal Resistance ^{1,2}	Compressive Strength (lb/in ²), min., core foam	Flexural Strength (lb/in ²), typ. for 1" core foam	Water Absorption (% increase by volume, 2-hr. results), max., core foam	Water Vapor Permeance ³ (perm)	Dimensional Stability (% linear change), max.	Complies with ASTM	Maximum Use Temperature (°F)	Flame Spread ⁴ , max., core foam	Smoke Developed, max., core foam	Width (inches)	Length (inches)	Typical Thickness Range (inches), core foam
ASTM Method	C518	D1621	C203	C209	E96	D2126	C1289		E84	E84				
ISOCAST™ R	6.5	25	55	0.05	<0.03	1.0	Type I Class 1 or 2 ⁵	190	55	200	48	96		1.0, 1.5, 2.0
Super TUFF-R™ Commercial	6.5	25	55	0.1	<0.03	1.0	Type I Class 1 or 2 ⁵	190	55	200	16 48 48	96 96 108		0.5, 0.75, 1.0, 1.5, 1.75, 2.0
THERMAX™ (c) Exterior Insulation	6.5	25	55	<0.05	<0.03	1.5	Type I Class 2	250	25	185	48 48	96 144		0.625, 1.0, 1.55, 2.0, 2.5, 3.0
THERMAX™ Heavy Duty	6.5	25	55	0.1	<0.03	1.5	Type I Class 2	250	25	185	48 48	96 120		1.0, 1.25, 1.55, 1.75, 2.0, 2.5, 3.0
THERMAX™ Heavy Duty Plus	6.5	25	55	0.05	<0.03	1.5	Type I Class 2	250	25	185	48 48	96 120		1.0, 1.25, 1.55, 1.75, 2.0, 2.5
THERMAX™ Light Duty	6.5	25	55	0.05	<0.03	1.5	Type I Class 2	250	25	185	48 48	96 120		0.5, 0.75, 1.0, 1.25, 1.55, 1.75, 2.0, 2.5, 3.0
THERMAX™ Metal Building Board	6.5	25	55	0.05	<0.03	1.5	Type I Class 2	250	25	185	48 48	96 120		0.5, 0.75, 1.0, 1.75, 2.0, 2.5, 3.0, 3.5, 4.0
THERMAX™ Sheathing	6.5	25	55	0.05	<0.03	1.5	Type I Class 2	250	25	185	48	96, 108, 120, 144		0.5, 0.75, 1.0, 1.5, 1.55, 2.0, 2.5, 3.0, 3.5, 4.0
THERMAX™ White Finish	6.5	25	55	0.05	<0.03	1.5	Type I Class 2	250	25	185	48	108		0.5, 0.75, 1.0, 1.25, 1.5, 1.55, 1.75, 2.0
TUFF-R™ Commercial	6.5	25	55	0.05	<0.03	1.5	Type I Class 1 or 2 ⁵	190	55	200	48	96, 108		1.0, 1.25, 1.50, 1.875, 2.0

- (1) Aged R-value per 1" of core foam @ 75°F mean temperature. R-values are expressed in ft²•h•°F/Btu.
- (2) R means resistance to heat flow. The higher the R-value, the greater the insulating power. R-values determined by ASTM C518 using the aging process in ASTM C1289 (90 days @ 140°F).
- (3) Water vapor permeance varies with product type and thickness. Values are based on the desiccant method, and they apply to insulation 1" in thickness. Thicker products have lower permeance.

- (4) These numerical flame spread ratings are not intended to reflect hazards presented by this or any other material under actual fire conditions.
- (5) Varies with thickness.

Note: Not all products are available in all parts of the country. Other product sizes are available on a made-to-order basis. Custom lengths of THERMAX™ Insulation products are available for orders of 7,500 board feet or more. Contact your Dow representative with questions.

DOW POLYURETHANE FOAM INSULATION

Physical Properties	Property (units)	Flexural Strength (lb/in ²), parallel	Thermal Resistance, R-value per inch, ft ² •hr•F/Btu	Compressive Strength (lb/in ²), parallel	Tensile Strength (lb/in ²), parallel	Shear Strength (lb/in ²), parallel	Apparent Core Density (lb/ft ³)	Water Absorption (% by volume)	Water Vapor Permeance (perm)	Cure Time	Application Temperature (°F)	Sizes
ASTM Method		C203	C518	D1621	D1623	C273	D1622	D2842	E96			
FROTH-PAK™ Foam Insulation (CLASS A)		19.7	4.6 ⁽¹⁾	31.8	12.5	17.74	2.0	1.1	5.1	Tack-free ⁽²⁾ <1 min.	60-90	Selection of kit sizes and refill systems available
STYROFOAM™ SPF (CM Series) ⁽³⁾	2045	NA	6.4 ⁽⁴⁾	26	55	NA	2.2	1.6	0.7	NA	45-95 Ambient (45-100 Substrate)	55 gal drums (one ISO, one polyol)
	2060	NA	6.1 ⁽⁴⁾	26	56	NA	2.2	3.2	1.4	NA	60-100 Ambient (60-120 Substrate)	

(1) Aged R-value: 90 days at 140°F. Initial R-value: 6.6.

(2) Actual cure time will depend on temperature, foam thickness, specific nozzle used, etc.

(3) Approved for use exclusively with the THERMAX™ Wall System.

(4) Aged R-value: 90 days at 140°F.

DOW POLYURETHANE FOAM SEALANTS AND ADHESIVES

Product	Cure Time	Size	Yield ⁽¹⁾
FROTH-PAK™ Foam Sealant ^(2,3)	Tack-free <1 min.	Selection of kit sizes and refill systems available	12-620 bd ft Refill Systems 2,000-43,900 bd ft
GREAT STUFF PRO™ Gaps & Cracks ⁽⁴⁾	Tack-free within 6 mins, trim in 30; full cure 1 hour	20 oz can, reusable straw 20 oz can, gun 26 oz can, reusable straw 26 oz can, gun	646 ft ⁽⁵⁾ 839 ft ⁽⁵⁾ 867 ft ⁽⁵⁾ 1,142 ft ⁽⁵⁾
GREAT STUFF PRO™ Window & Door ⁽⁴⁾	Tack-free within 9 mins, trim 1 hour; full cure 12 hours	20 oz can, reusable straw 20 oz can, gun 24.5 oz can, reusable straw 24.5 oz can, gun	6-9 windows ⁽⁶⁾ 8-11 windows ⁽⁶⁾ 8-11 windows ⁽⁶⁾ 11-14 windows ⁽⁶⁾
INSTA STIK™ Quik Set	Tack-free 3-7 mins, depending on humidity	31 lb canister only (23 lb net chemical weight)	8 squares/tank (refer to E-Z Estimating Guide, Form No. 179-05069)
TILE BOND™	Tack-free 5-15 mins	23 lb complete (canister with gun/hose assembly) 23 lb canister only 28 oz can with reusable straw	Up to 350 field tiles for 23 lb

(1) For estimated yields at other product sizes, bead sizes and conditions, contact your Dow representative or call 1-866-583-BLUE (2583).

(2) FROTH-PAK™ products are available in a selection of densities, formulations and sizes to meet a wide range of project specifications.

(3) Actual cure time will depend on temperature, foam thickness, the specific nozzle used, etc.

(4) Actual cure time will depend on temperature, relative humidity and size of foam bead.

(5) Estimated yield under ideal conditions based on gun foam, 3/8" bead.

(6) Estimated yield (gun foam) under ideal conditions for 36" x 60" window, 3/8" wide gap, 1" deep, 3/8" bead.

WEATHERMATE™ STRAIGHT FLASHING

Property	Value
Water Vapor Transmission, ASTM E96, perm	<1
Application Temperature, °F, min.	30
UV Resistance, days	180
Size	4" x 100', 6" x 100', 9" x 100'

STYROFOAM™ SILL SEAL FOAM GASKET

Nominal Thickness x Width	Roll Length
.25" x 3.5"	50'
.25" x 5.5"	50'

For more detailed installation information, contact your Dow representative or refer to the product literature.

©™Trademark of The Dow Chemical Company ("Dow") or an affiliated company of Dow

A RECOGNIZED INDUSTRY
LEADER IN ENERGY-EFFICIENT
SOLUTIONS FOR MORE THAN 60
YEARS, DOW IS COMMITTED
TO DEVELOPING INNOVATIVE
PRODUCT SOLUTIONS TO HELP
SOLVE THE WORLD'S ENERGY
AND CLIMATE CHALLENGES.

TO LEARN HOW TO MAKE YOUR MARK, CALL YOUR
DOW REPRESENTATIVE AT 1-866-583-BLUE (2583)
FOR MORE DETAILS, OR VISIT
WWW.DOWBUILDINGSOLUTIONS.COM.

For Technical Information: 1-866-583-BLUE (2583) . For Sales Information: 1-800-232-2436
THE DOW CHEMICAL COMPANY . Dow Building Solutions . 200 Larkin . Midland, MI 48674
www.dowbuildingsolutions.com

Illustrations are not intended to replace the need for design by appropriate professionals such as architects or engineers.

Dow has manufactured STYROFOAM™ Brand Extruded Polystyrene Foam Insulation for use in construction and specialty applications for more than 60 years. Its dense closed-cell structure gives STYROFOAM™ Brand Extruded Polystyrene Foam Insulation excellent moisture resistance, long-term thermal performance and compressive strength. STYROFOAM™ Brand Extruded Polystyrene Foam Insulation is reusable in many applications.

NOTICE: No freedom from any patent owned by Dow or others is to be inferred. Because use conditions and applicable laws may differ from one location to another and may change with time, Customer is responsible for determining whether products and the information in this document are appropriate for Customer's use and for ensuring that Customer's workplace and disposal practices are in compliance with applicable laws and other government enactments. Dow assumes no obligation or liability for the information in this document. NO EXPRESS WARRANTIES ARE GIVEN EXCEPT FOR ANY APPLICABLE WRITTEN WARRANTIES SPECIFICALLY PROVIDED BY DOW. ALL IMPLIED WARRANTIES INCLUDING THOSE OF MERCHANTABILITY AND FITNESS FOR A PARTICULAR PURPOSE ARE EXPRESSLY EXCLUDED.

STYROFOAM™ Brand Extruded Polystyrene Foam Insulation

CAUTION: This product is combustible. Protect from high heat sources. A protective barrier or thermal barrier may be required as specified in the appropriate building code. For more information, consult MSDS, call Dow at 1-866-583-BLUE (2583) or contact your local building inspector. In an emergency, call 1-989-636-4400.

Dow Polyisocyanurate Insulation

CAUTION: This product is combustible and shall only be used as specified by the local building code with respect to flame spread classification and to the use of a suitable thermal barrier. For more information, consult MSDS, call Dow at 1-866-583-BLUE (2583) or call your local building inspector. In an emergency, call 1-989-636-4400.

WARNING: Rigid foam insulation does not constitute a working walkable surface or qualify as a fall protection product.

STYROFOAM™ Brand Spray Polyurethane Foam contains isocyanate, hydrofluorocarbon blowing agent and polyol. Read the instructions and Material Safety Data Sheets carefully before use. Wear protective clothing, gloves, goggles and proper respiratory protection. Supplied air or an approved air-purifying respirator equipped with an organic vapor sorbent and a particle filter is required to maintain exposure levels below ACGIH, OSHA, WEEL or other applicable limits. Provide adequate ventilation. Contents under pressure. STYROFOAM™ Brand SPF should be installed by a trained SPF applicator.

FROTH-PAK™ Polyurethane Spray Foam contains isocyanate, hydrofluorocarbon blowing agent and polyol. Read the instructions and Material Safety Data Sheets carefully before use. Wear protective clothing, gloves, goggles or safety glasses, and proper respiratory protection. Supplied air or an approved air-purifying respirator equipped with an organic vapor sorbent and a particle filter may be required to maintain exposure levels below ACGIH, OSHA, WEEL or other applicable limits. Provide adequate ventilation. Contents under pressure.

GREAT STUFF PRO™ Insulating Foam Sealants contain isocyanate and a flammable blowing agent. Read the label and Material Safety Data Sheet carefully before use. Eliminate all sources of ignition before use. Wear gloves, and goggles or safety glasses. Provide adequate ventilation or wear proper respiratory protection. Contents under pressure.

INSTA STIK™ Quik Set Commercial Roofing Adhesive and TILE BOND™ Roof Tile Adhesive contain isocyanate and a hydrofluorocarbon blowing agent. Read the label and Material Safety Data Sheet carefully before use. Wear gloves, and goggles or safety glasses. Provide adequate ventilation or wear proper respiratory protection. Contents under pressure.

Building and/or construction practices unrelated to building materials could greatly affect moisture and the potential for mold formation. No material supplier including Dow can give assurance that mold will not develop in any specific system.

Published August 2009

